

WLC PRECISION BALANCES









release date 11-03-2016



Balances series WLC are designed for fast and precise mass determination in laboratory and industrial conditions. They can also be used in areas with no access to mains (230V), as their standard equipment they includes internal rechargeable battery and RS 232 output. WLC series, independently on model (pan size: 195×195, 300×300 and 400×500 mm) and capacity, features stainless steel weighing platform and backlit LCD display providing good reading of weighing result.

Balances series A2 offer the possibility of weighing loads outside weighing platform (so called under hook weighing), where a load is hanged under the instrument. This is an alternative for weighing loads with non-standard dimensions and shapes.

-  Parts counting
-  Percent deviations
-  Checkweighing
-  Animal weighing
-  Totalizing
-  Peak hold
-  Newton unit measurement

Technical specification:

	WLC 1/A2	WLC 2/A2	WLC 10/A2	WLC 20/A2
Max capacity	1 kg	2 kg	10 kg	20 kg
Minimal load	-	-	-	-
Reading unit [d]	0,01 g	0,01 g	0,1 g	0,1 g
Verification unit [e]	-	-	-	-
Tare range	-1 kg	-2 kg	-10 kg	-20 kg
Repeatability	0,01 g	0,01 g	0,1 g	0,1 g
Linearity	±0,03 g	±0,03 g	±0,3 g	±0,3 g
Pan size	195 × 195 mm			
OIML Class	-	-	-	-
Interface	RS 232			
Power supply	11V AC, 10,5 +15V DC I _{max} =600mA, and accumulator			
IP rating	IP 43			
Stabilization time	3 s			
Working temperature	+15° + +30 °C			
Display	LCD			
Net weight / Gross weight	2,8 kg / 4,3 kg			
Packaging dimensions	440 × 280 × 190 mm			

Technical specification:

	WLC 6/F1/R WLC 6/F1/K M	WLC 30/F1/R WLC 30/F1/K	WLC 60/C2/R WLC 60/C2/K M
Max capacity	6 kg	30 kg	60 kg
Minimal load	5 g	-	50 g
Reading unit [d]	0,1 g	0,5 g	1 g
Verification unit [e]	1 g	-	10 g
Tare range	-6 kg	-30 kg	-60 kg
Repeatability	0,1 g	0,5 g	1 g
Linearity	±0,3 g	±1,5 g	±2 g
Pan size	300 × 300 mm		400 × 500 mm
OIML Class	II	-	II
Interface	RS 232		
Power supply	11V AC, 10,5 +15V DC I _{max} =600mA, and accumulator		
IP rating	IP 43		
Stabilization time	3 s		
Working temperature	+15° + +30 °C		
Display	LCD		
Net weight / Gross weight	5,2 kg / 6 kg		12,5 kg / 15 kg
Packaging dimensions	570 × 390 × 170 mm		720 × 580 × 220 mm

Dimensions:

A2 version

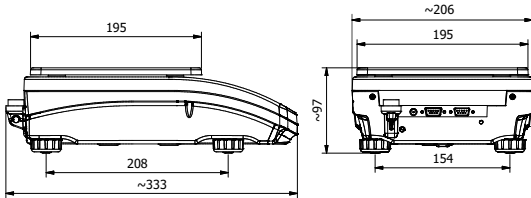

C2/R version

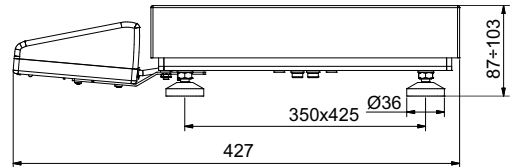

C2/K version

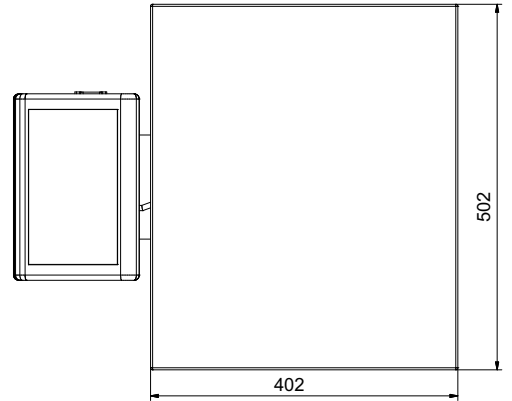
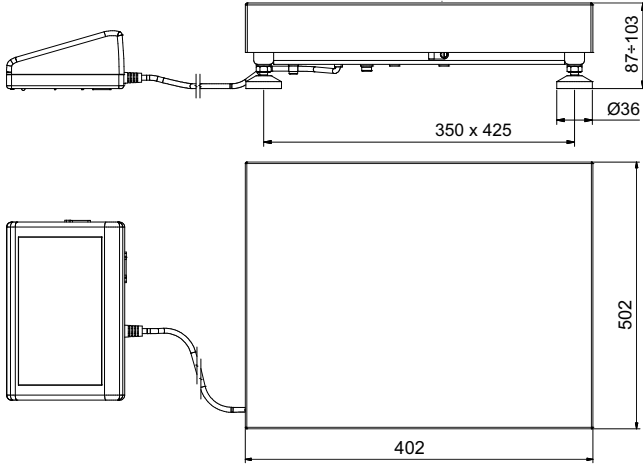

WPT F1/K version

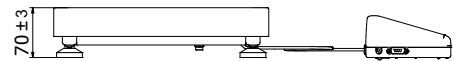

WPT F1/R version

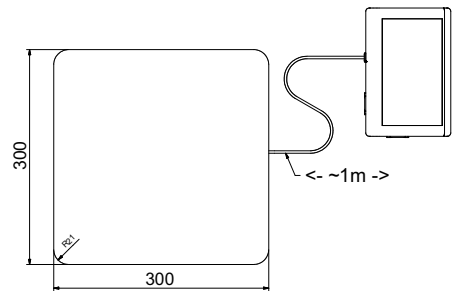
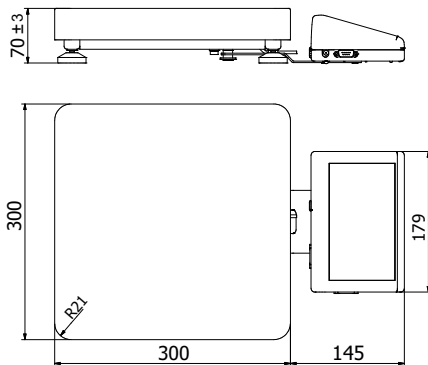

Additional equipment:

EPSON TM-U220D, TM-U220B, TM-U220A PRINTER

DENSITY DETERMINATION KIT FOR SOLIDS AND LIQUIDS

RACK FOR UNDER HOOK WEIGHING

EXTERNAL BATTERY PACK WITH CHARGER

ADDITIONAL LCD DISPLAY

COMPUTER SOFTWARE PW-WIN, RAD-KEY

SUITCASE FOR BALANCE